



#Z&S

HVSP-F SERIES

>A 36 E7@E;@9 BDABADF;A@3>
5A@FDA > H3>H7

: HEB

@a_ [S^e] W	#\$8	\$" 8
DSfW bd/tegdWT Sdfbg_ b e[VW	% "	% "
SUfgSfade[VW	&\$"	&\$"
DSfW ai />!_ [fj	#\$"	&" "

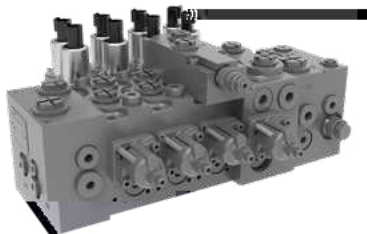

: HEB#\$8

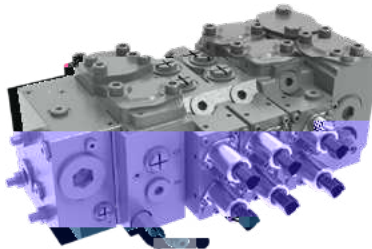

: HEB\$" 8

5a` fW fe

BSYW

8V8fgdWé

01

EWV[a`h]W

: HEB#S/>[X] Y EWF[a`fj

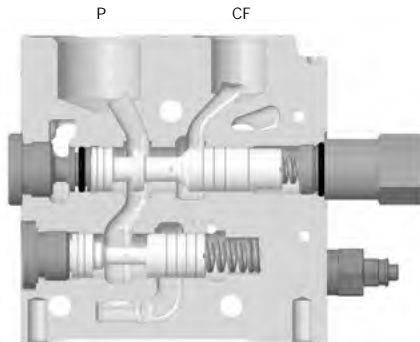
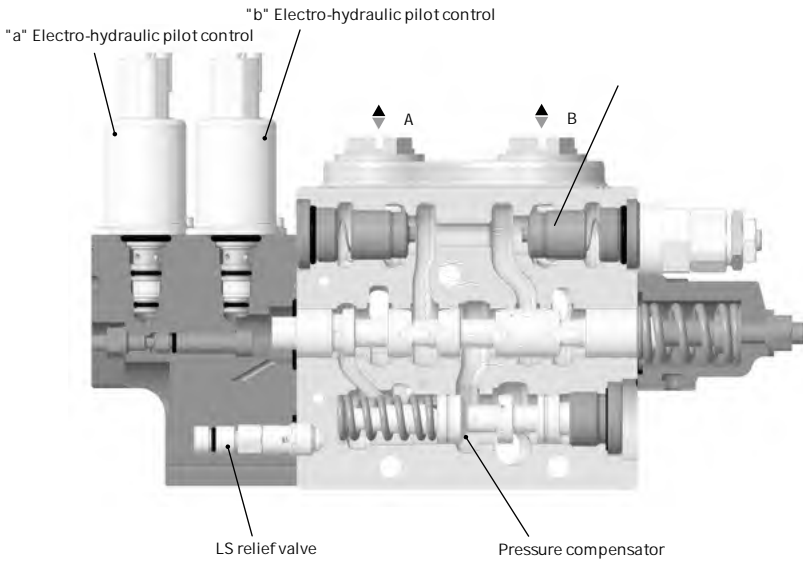

01

AdV₁ Y UaVW

01

[Shaded Area]	[Shaded Area]	[Shaded Area]			
		[Shaded Area]			
	[Shaded Area]	[Shaded Area]			
		[Shaded Area]			
		[Shaded Area]			
		[Shaded Area]			
		[Shaded Area]			
		[Shaded Area]			
		[Shaded Area]			
		[Shaded Area]			
[Shaded Area]	[Shaded Area]				
	[Shaded Area]				
	[Shaded Area]				
	[Shaded Area]				
[Shaded Area]	[Shaded Area]				
	[Shaded Area]				
	[Shaded Area]				
[Shaded Area]	[Shaded Area]				

: kVdsg'UV[SYdδ_

%oHEB#\$8

01

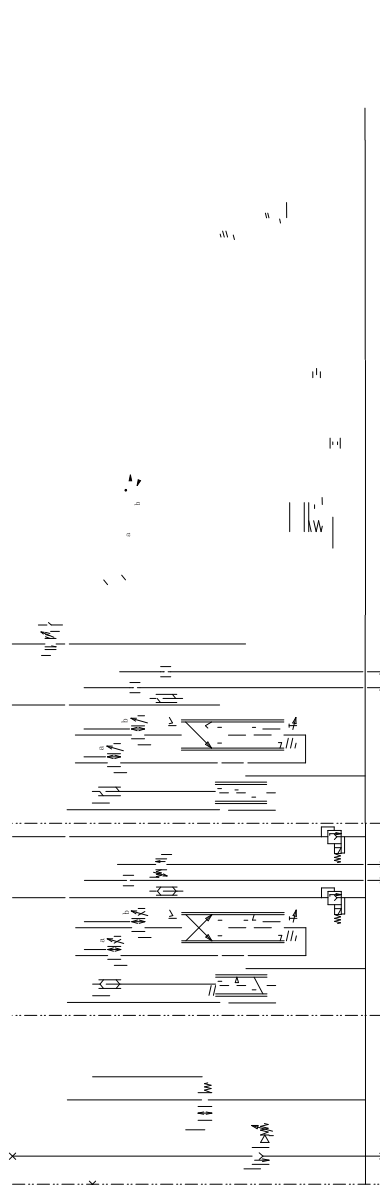

: kVdSg^UV[SYdS_

%oHEB\$" 8

01

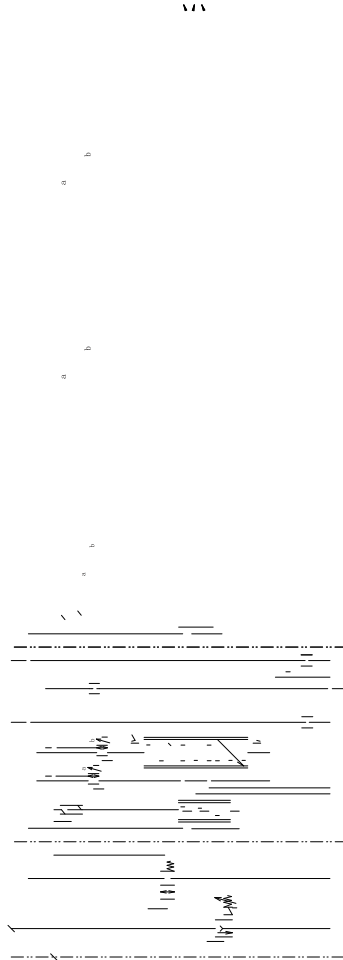

01

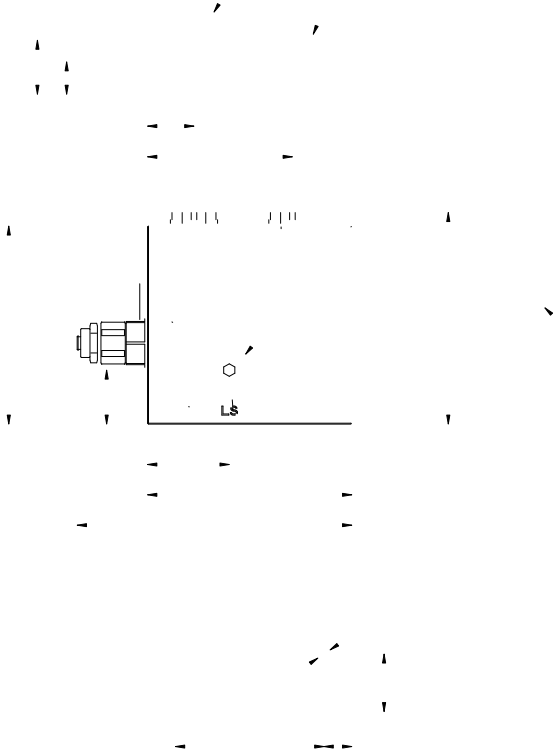

W E W [a ` A b W 5 W f W

% o H E B # \$ 8

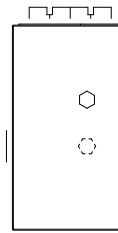
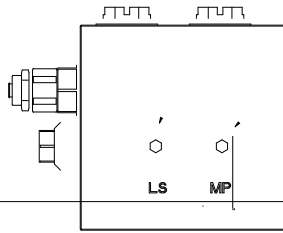
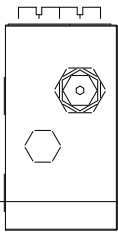
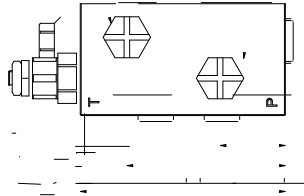

01

01

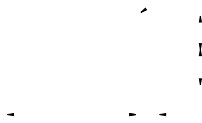
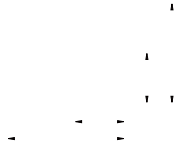

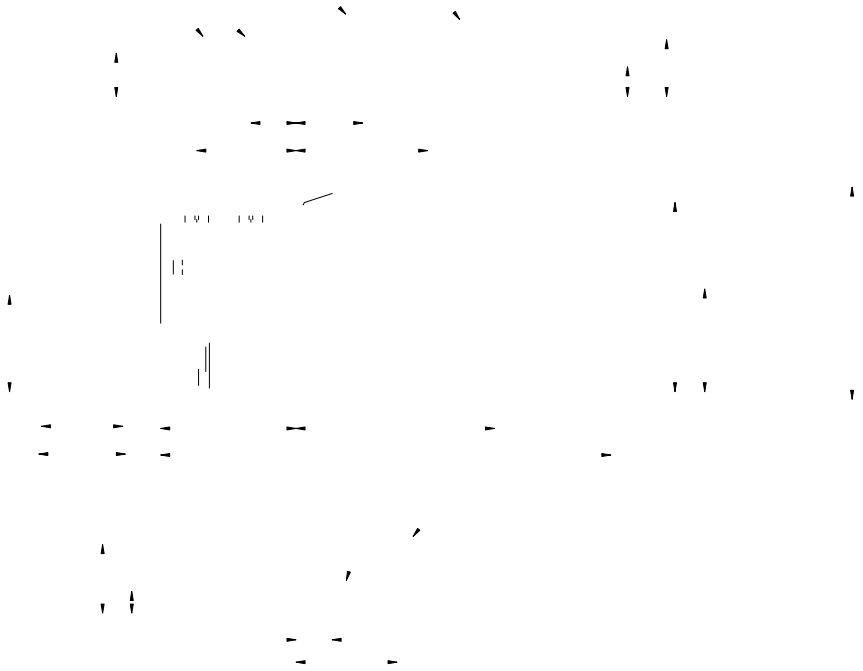

01

01

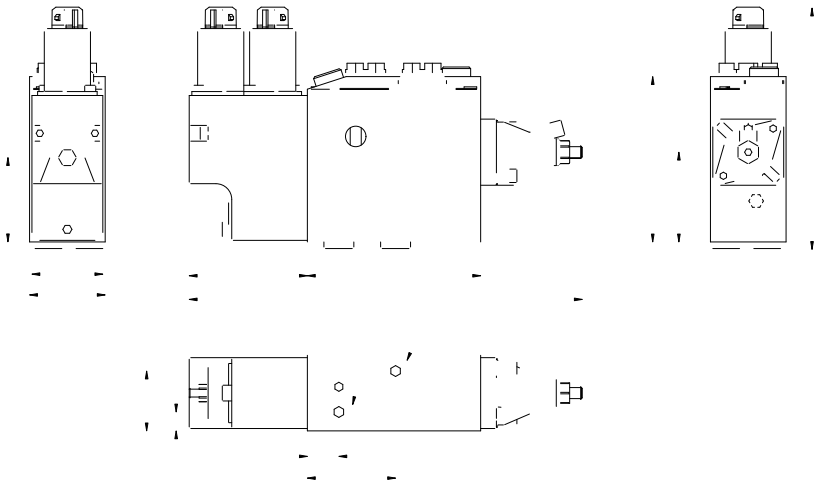

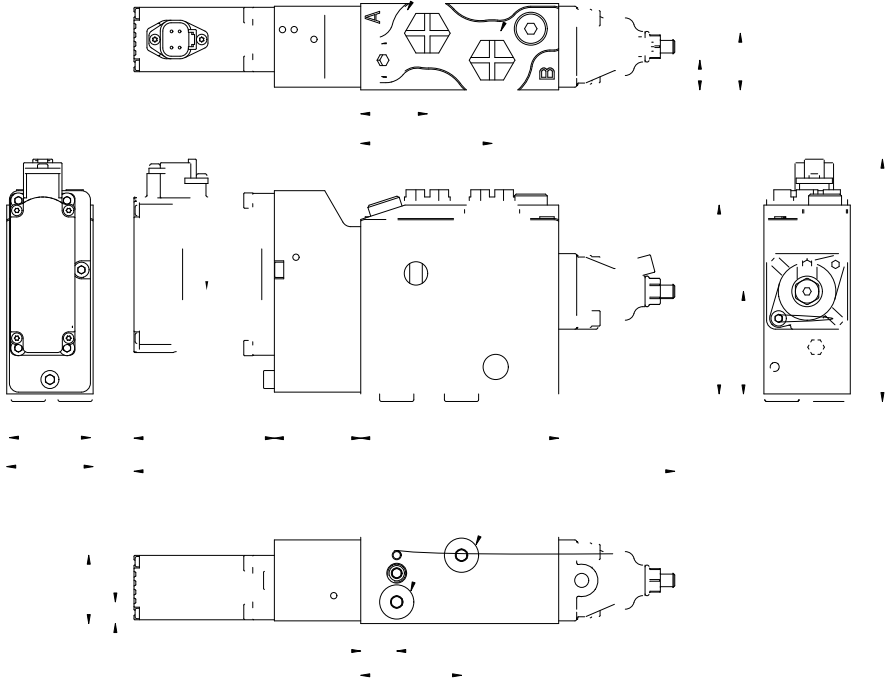

01

>[X[Y EWf[a` 7^WfdažZkVdSg^U5a` fda^

%oHEB#\$8

01

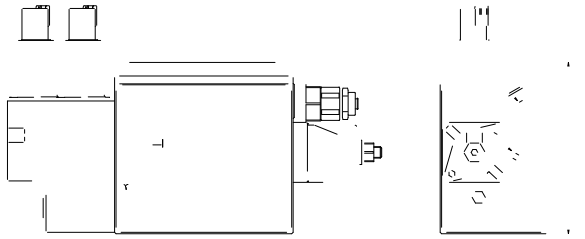

F [f[Y E W f [a` 7 ^ W f da Ž k V d S g (U 5 a` f da ^

% o H E B # \$ 8

7` V EWW[a` 1 [fZagf 3VV[f[a` S^B Badffi

%oHEB#\$8

01

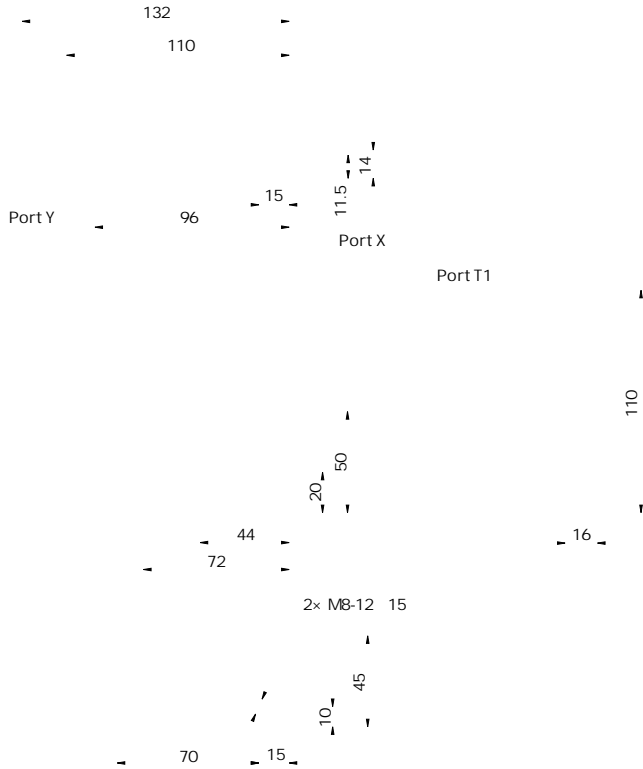

∫ √EWf[a` 5^aeW 5W fVd

%oHEB\$" 8

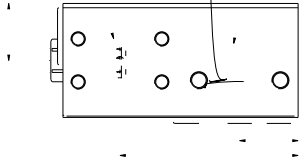

01

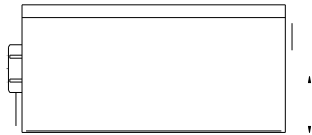
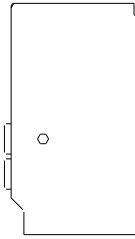
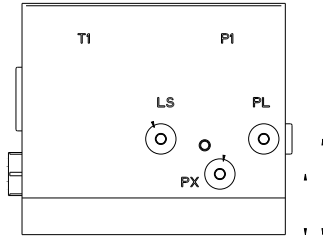
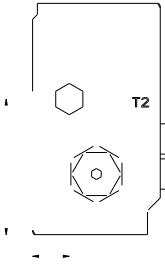

AbW 5W fW

8

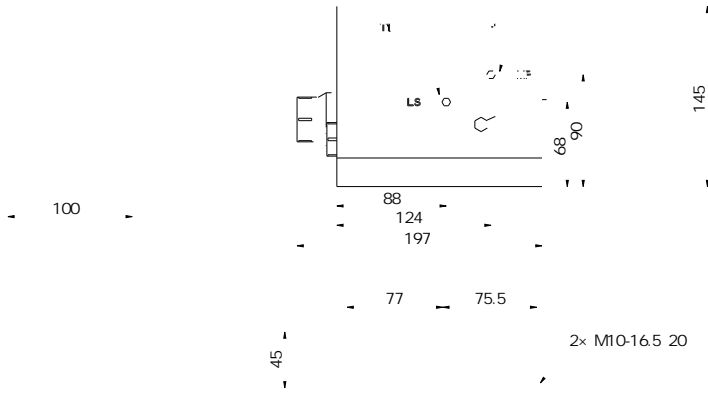
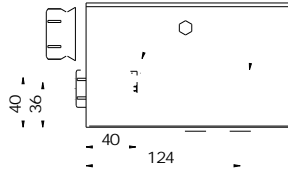

01

;` fVd_ W[SfWEWf[a` : kVdSg^U5a` fda^

%oHEB\$" 8

01

;\ fVd_ W[SfVVEWf[a` 7^WfdaZkVdSg(U5a` fda^

%oHEB\$" 8

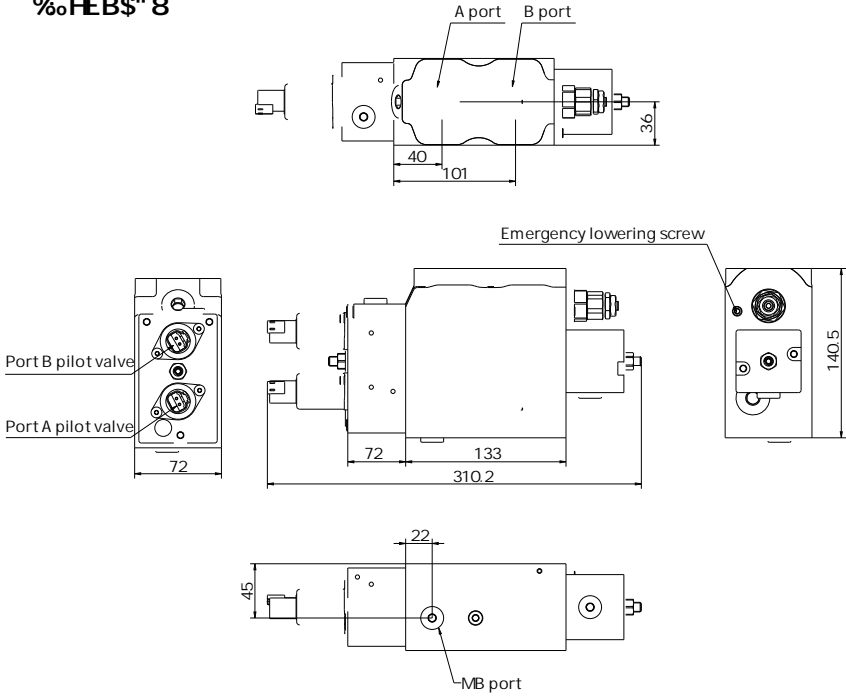

01

01

;\ fVd_ W[SfVEWf[a` ;\ fVdSfW EfVWd Y Bdadfk

%oHEB\$" 8

P port

EF port

CF port

LS port

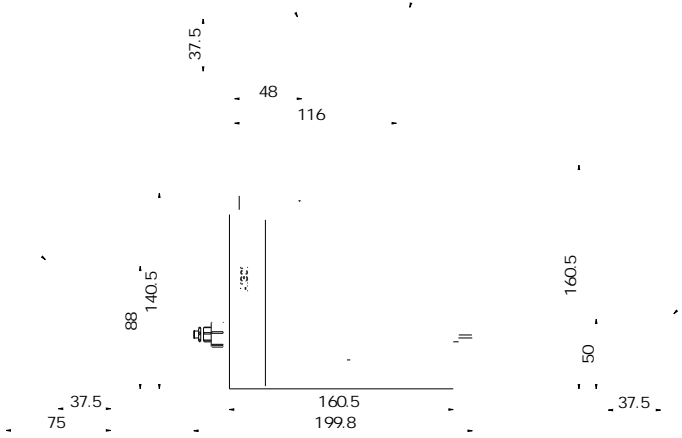

01

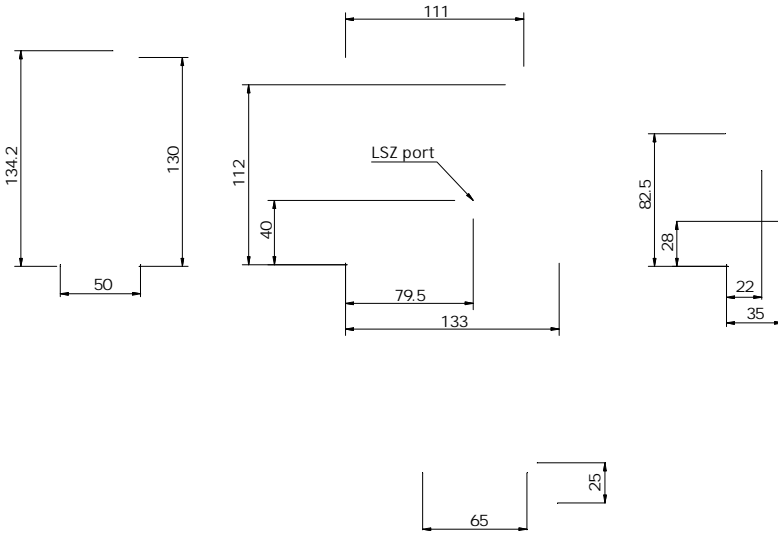

7` V EWf[a` 1 [fZ 3VW[f[a` S^B Badffi

%oHEB\$" 8

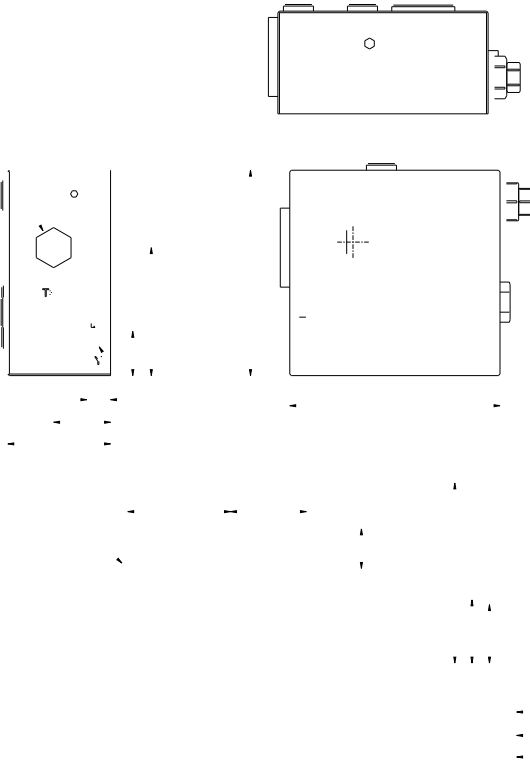

01

BdWdW ebaa^ ai

%oHEB\$" 8

%Ek_ _ Wd[US^FkbW

BdWdgdM5a_ bW eSfadFkbWB'ai />!_ [fi

E	# " Z# " # \$ Z# \$ " " * " Z' * " " ' " Z' " " % Z' % \$ " \$ Z' \$ %
	# & " Z# & " # % Z# % " # " Z# " ") " Z' " " & " Z' & " \$ * Z' \$ * " \$ " Z' \$ "
	# \$ " Z# \$ " ## " Z## " " * " Z' * " (" Z' (" " & " Z' & " \$ ' Z' \$ ' " #) Z' # "
5	\$ " Z\$ " #) ' Z# ' # & ' Z# & ## " Z## " " * " Z' * " " & ' Z' & " \$ * Z' \$ *
F	# + " Z# + " # (" Z# (" # " " Z# " " (' " Z' (' " & " Z' & "

%dek_ _ Wd[US^FkbW

BdWdgdM5a_ bW eSfadFkbWB'ai />!_ [fi

E	# " Z# \$ " # \$ " Z# * " " * " Z' " " ' " Z' % \$ " \$ Z' # &
	# % Z## " # " " Z') " ") " Z' & " & " Z' \$ * " \$ " Z' # \$
	## " Z' * " " * " Z' (" " (" Z' & " & " Z' \$ ' " #) Z' # "
5	#) ' Z# & ' # & ' Z## " ## " Z' * " " * " Z' &
F	# + " Z# (" # (" Z# " " # " " Z' (' " (' Z' & " \$ * Z' # "

Tj S_ b^W

Ea'gf[a` ,

f|BdWdgdM5a_ bW eSfad E ##" >!_ [ebaa^t e \$Z[e /# " >!_ [

f|Dvtg[dW 8'ai HS'gWCSU/ #&' >!_ [EW fa #&' >!_ [h[S efc] W[_ fWd

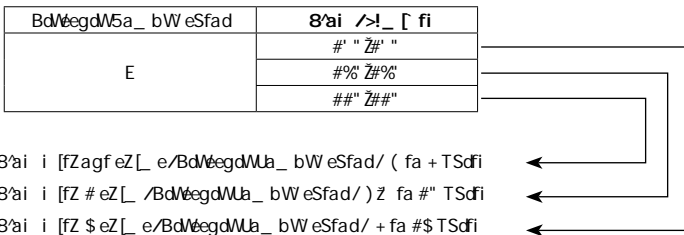

%>Df[YEWf[a` Abf[a` S^

BdWdgdM5a_ bW eSfadFkbWB'ai />!_ [fi

? Sj z ai &" >!_ [

E	" Z& " " Z\$ " "
---	------------------

G` [f V[We[a` e

%oHEB\$" 8

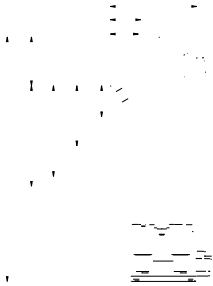

01

BdWegdMa_bWeSfadfbW

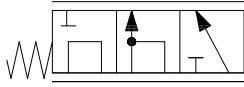

5aVWE

I [fZ bdWegdMa_bWeSfad
I [fZ 'aSV Za'V[Y Xg' Uf[a`

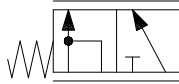

5aVWF

I [fZ bdWegdMa_bWeSfad
I [fZagf 'aSV Za'V[Y Xg' Uf[a`

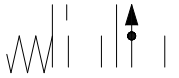

5aVW5

I [fZagf bdWegdMa_bWeSfad
I [fZ 'aSV Za'V[Y Xg' Uf[a`

7` V VWY Wfeabf[a`

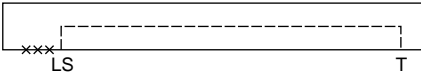

7` V VWY Wf i [fZ >E g` 'aSV[Y
Ad/Vd[Y laVW >3

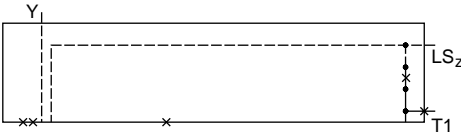

7` V VWY Wf i [fZagf >E g` 'aSV[Y
Ad/Vd[Y laVW >L
EZacf VWUd[bf[a`
Egbb'k aXfS` VW_ ei [fUZ VW >E e[Y' S'e

A`ŽTasD/WWfda` [Ue, A 47

4k Ua_ bSc` Y fZV` bgf hS`gWkba_ fZVUa` fca`^WV_ W f
 /bafW f[a_ WV abWsf` Y ZS` V`WadZaef Ua_ bgfVfii [fZ
 fZVWWTsu] hS`gWkba_ fZVWg[fZ` Z[YZ`bdu[e]a` : S`^
 W WUf bae]f[a` eW ead fZ[e U`aeVW`Z`aab Ua` fca`^kefV_
 W ST`V`fZWebaa`V[e]b`SUW_ W f Ua` fca`^SUgdSuk fa
 SbbdaSUZ fZVbW`da`_ S` UW`WV`aXS eV`ha hS`hV`



01

6!5"

#ž Bai V`Egbb`k Baef[hW

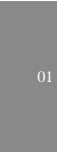

01



y FZ[eTdULZgdMUS` T WdVbdaVgUWV! VWfVW! dVbdaVgUWV ad
 fdS_e_ [fVW VWUfcb` [L5*k i [fZagf fZWSgfZad] Sfja` aX: WY↑
 : kVdSg↑U 5a_ bS` kz6gWfa fZWUa` f[gage VWWWb_ W f aX
 fZVbdaVgUf fZVW` Xad_ Sfja` [fZ[eTdULZgdMe` af ebVU[Ufa
 fZWebVU[ULa` V[f]a` e adSbb↑LST[↑fk aXfZW[Vgefcki fZget
 : WY↑VaVe` af fS]WS` k dVeba` eT[↑fk XadS` k [Ua_ bVWVad
 [SUJgdFVWVUdbrfa` z